

Data Sheet



Article number: 071581360545040

Description: Cardan drive shaft 0.158.136.001
S=545 X=40 Bore with keyway

Measures

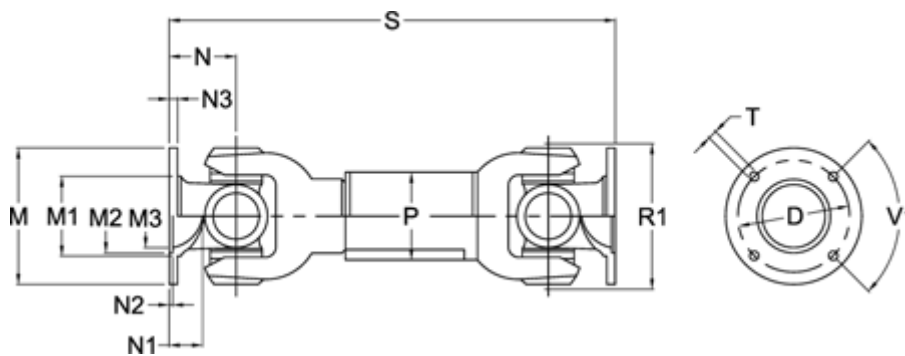

D	= 155,5 +-0,1	N1	= 25	T	= 14 b1
Extension X	= 40	N2	= 3,6 +0,5	V1 degrees	= 45
Flange diameter M	= 180	N3	= 12		
M1	= 126	Number og Flangeholes	= 8		
M2	= 110	P	= 90x4		
M3	= 100	R1	= 150		
Max. Bending Angle degrees	= 35	S min	= 545		
N	= 90	Spline dim. DIN 5480	= 60x2,5x22		